

PC 1200

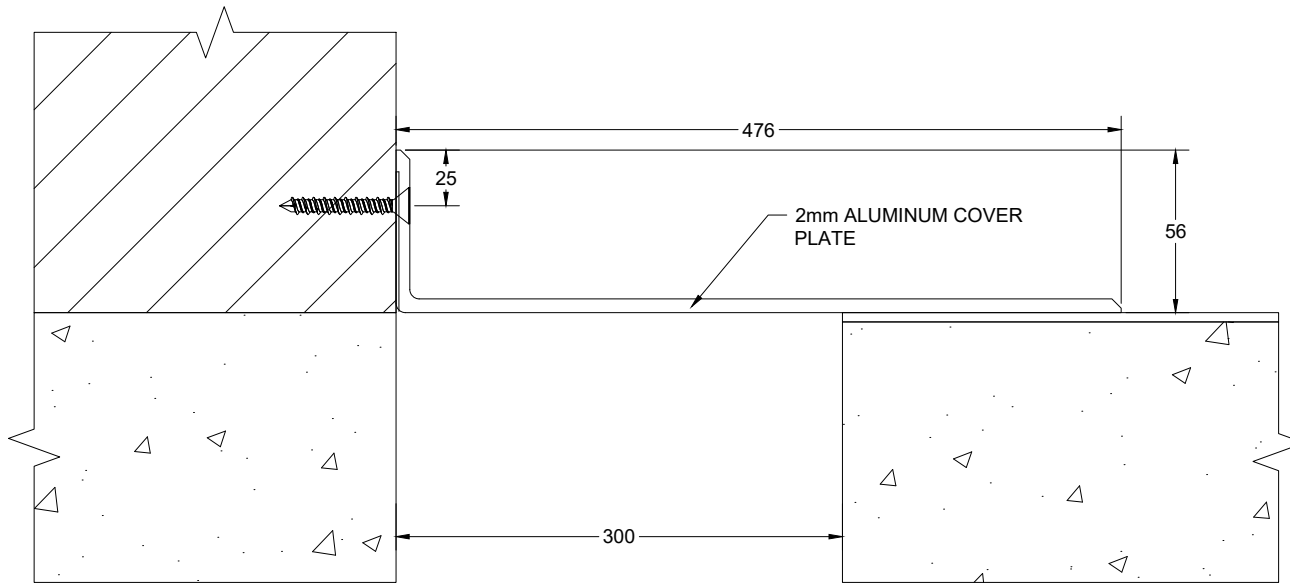

PCW 1200

GENERAL NOTES:-

1. THIS IS DRAWING IS A SOLE PROPERTY OF PINNACLE SOLUTIONS. DO NOT REPRODUCE THE DRAWING.
2. DO NOT SCALE ON THE DRAWING. USE ONLY THE SIZES/DISTANCE AVAILABLE.
3. ALL DIMENSIONS ARE IN MILLIMETRES OTHERWISE SPECIFIED.

REFERENCE DRAWING/DOCUMENT:

STATUS
ISSUED FOR APPROVAL

DATE	REV.	DRAWING NO.	Drawn By	Checked By	App'd



PROJECT TITLE

Drg. Title
EXPANSION JOINT DETAIL

Date: 03-08-2023 Scale: NTS

Drawing No: Rev. R0